

APPROVED BY: _____
 DATE : _____

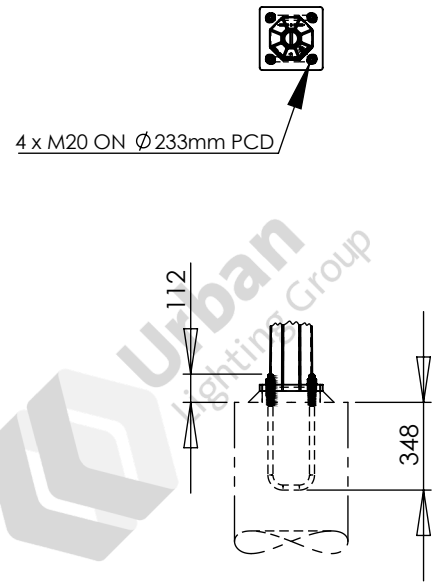
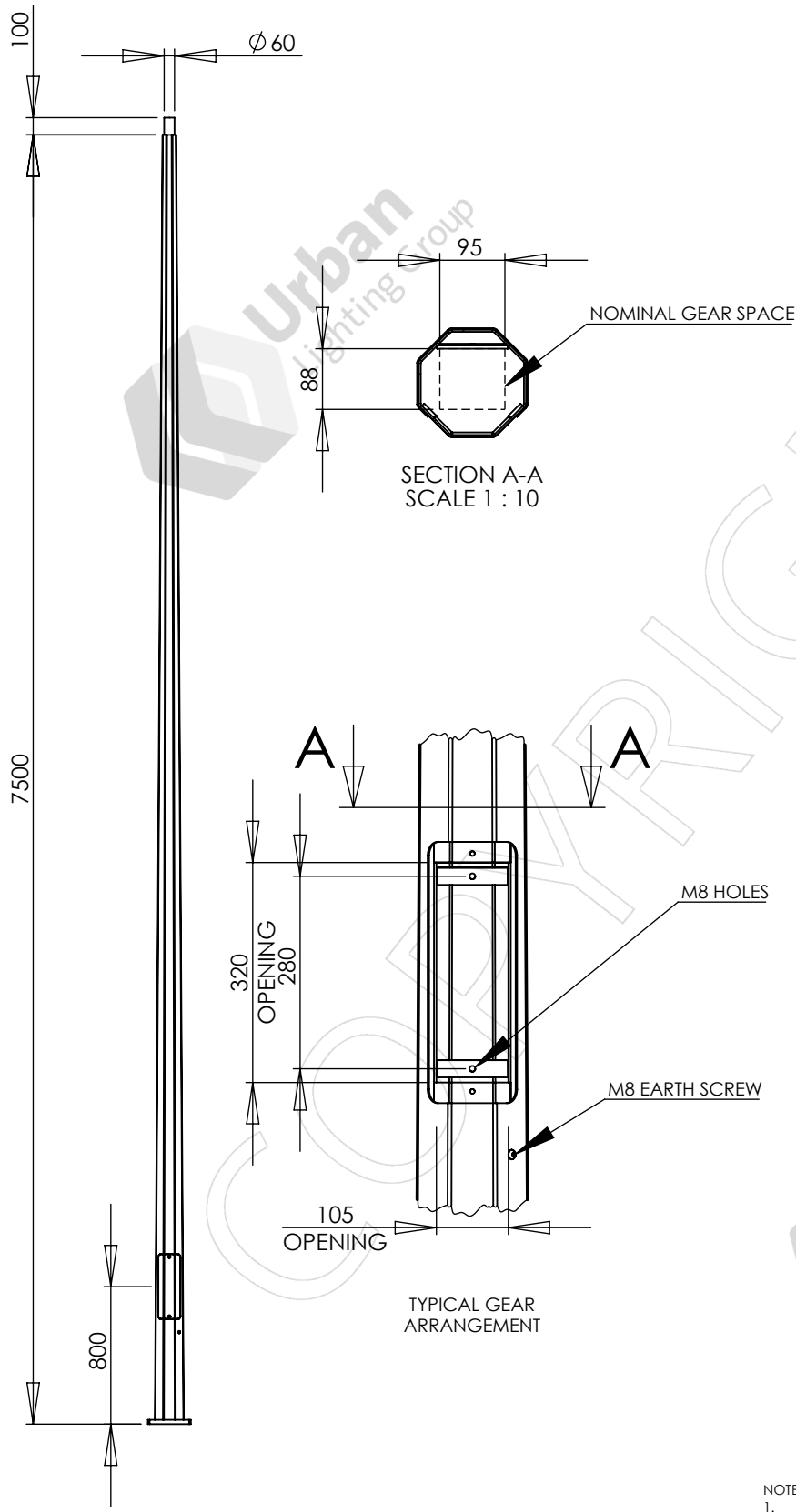

NOTES:
 1. LUMINAIRES AND CABLING ARE NOT INCLUDED UNLESS SPECIFICALLY LISTED ON THE QUOTATION.
 2. SEE QUOTATION FOR REINFORCING CAGE AND FOOTING DETAILS

DESIGNED AND MANUFACTURED TO:
 AS 1798 LIGHTING POLES AND ARMS - PREFERRED DIMENSIONS
 AS/NZS 1170.2 STRUCTURAL DESIGN ACTIONS - PART 2: WIND ACTIONS
 AS 4100 STEEL STRUCTURES
 AS 4680 HOT-DIP GALVANIZED (ZINC) COATINGS
 SEE DS-3040 FOR OTHER DESIGN STANDARDS

PARTS LIST					
ITEM NO.	PART NUMBER	DESCRIPTION	DRAWING NO.	REV.	QTY.
1	FL7.5XL1-60	COLUMN, 7.5m 1 SECTION 8 SIDED	ADL-21733	1	1
2	UBA-M20X233	U-BOLT ASSEMBLY, M20X233 PCD	ADL-20358	2	1

REV.	DESCRIPTION	DATE	BY	APP.	COLUMN, FL7.5XL1-60, 7.5m 1 SECTION 8 SIDED
1	INITIAL ISSUE	2024-08-30	KG	ME	
					COATING: GALVANIZED
					MAXIMUM LOAD: 0.60m ² 60kg
					WIND REGION: A, TC 2
					GROUND LOAD: M* 9.81kNm, V* 1.99kN
					WEIGHT: 84.1kg
					DO NOT SCALE
					SHEET 1 OF 1
					A4

Urban
Lighting Group
Innovative Streetscape Solutions

Urban Lighting Group Pty Ltd
 ABN 74 638 077 684
 28 National Drive, Hallam Victoria 3803
 T 1300 088 719
 email: sales@urbanlightinggroup.com.au

DRAWING NO. GA-11004
 REVISION 1